

# lediant®

## ***Nod Series Lens - LED Premium Dimmable Downlight Low Glare/Low Depth/High Performance***



***Nod Series is new designed Low Glare/Low Depth/High Performance LED Downlight. The biggest feature of Nod-Soft is changed into two forms of adjustable angle and non-adjustable angle through different magnetic face rings which can help you reduce half inventory. With 46mm depth, it can be allowed to be used on more place. Extremely high Colour Rendering Index (CRI) score of 95 makes them particularly suitable in situations where you want to enrich the vibrancy of colours. Lens type and reflector type are provided at the same time to meet various needs of customers.***



Dimmable

CRI

90

PF

0.9



IP44



Installation  
depth  
< 46 mm

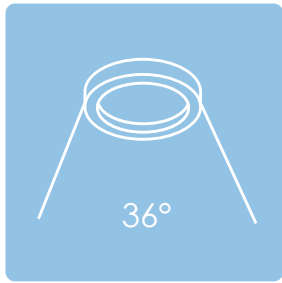

36°



Flicker Free

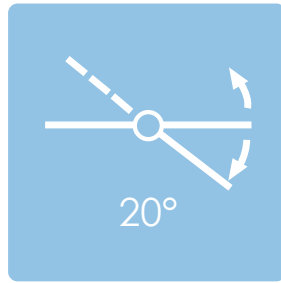

20°

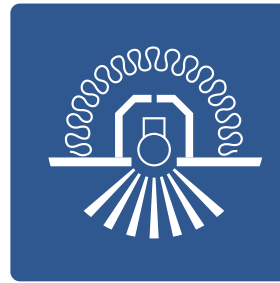

5  
YEARS

## **Reflector type**



## **Lens type**



**Chrome**

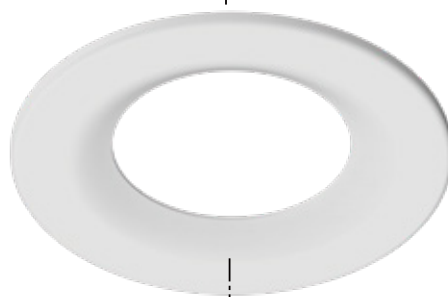

**White**

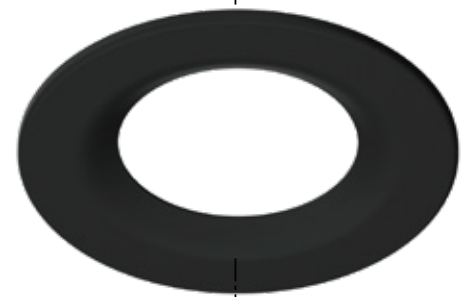

**Black**

## **Key Features:**

- **7w, Lumens 500lm, Ra≥95, SDCM<3**
- **CCT options 2700K/ 3000K/Dim to Warm**
- **Insulation coverable**
- **TRIAC Dimming both leading & Trailing Edge Dimmer**
- **Tool free Loop In/out Terminal**
- **Magnetic bezels (aluminium) available in White Back / Brushed steel**
- **Brand chips available in Bridgelux, Cree, Luminus.**
- **Lens type & reflector type are available**
- **Flicker Free driver**

CRI > 90



CRI < 80

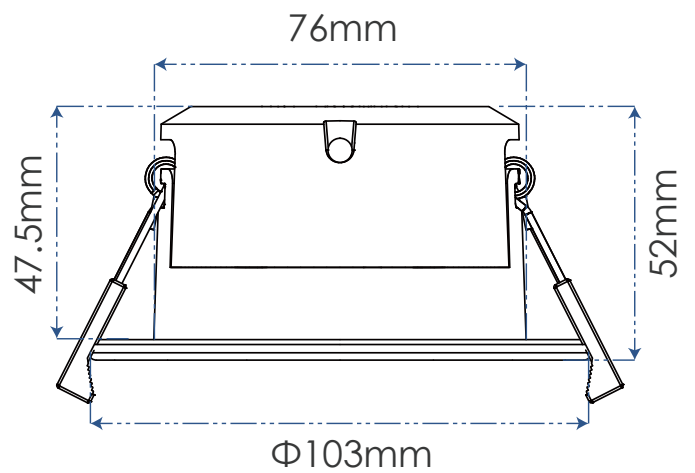
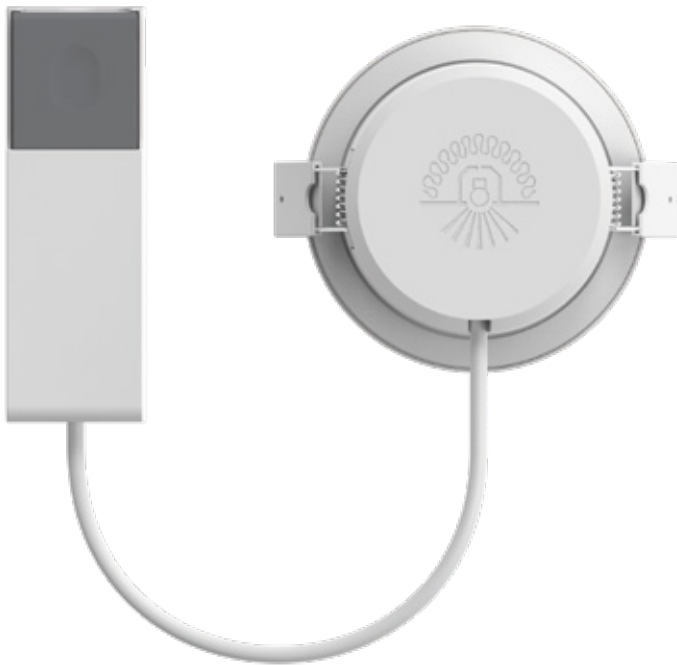

Item	Downlight	PF	≥0.9
Part No.	5RS200-1	IP	IP44
Power	7W	Cut Out	Φ 83mm
CCT	3000K/4000K/6000K	Driver	Isolated
Lumen	500 lm	Dimmable	Trailing & Leading Edge
Input	AC 220-240V~50Hz	Size	Drawing Supplied
CRI	90	LED	D2W
Beam Angle	36°	Switch Cycles	100,000
Lifespan	50,000hrs	Insulation Coverable	YES
House Material	Aluminum & Iron	Standard	CE ROHS

**Lediant**<sup>®</sup>

Suzhou Radiant Lighting Technology Co., Ltd.

<https://www.lediant.com/>

Add: Jiatai Rd(W), Shuanglong Industrial Park, Zhangjiagang, Jiangsu, China